

CURRENT 60 Ampere
VOLTAGE RANG 200 to 1000 Volts

MUR6020PT THRU MUR60100PTR

Features

- * Fast switching for high efficiency
- * Low forward voltage drop
- * High current capability
- * Low reverse leakage current
- * High surge current capability

Application

- * Automotive Inverters and Solar Inverters
- * Plating Power Supply, Motor Control, SMPS and UPS
- * Car Audio Amplifiers and Sound Device Systems

Mechanical Data

- * Case: Heatsink TO-247AD/247S/3P open metal package
- * Epoxy: UL 94V-0 rate flame retardant
- * Terminals: Solderable per MIL-STD-202 method 208
- * Polarity: As marked on diode body
- * Mounting position: Any
- * Weight: 0.65 gram approximately

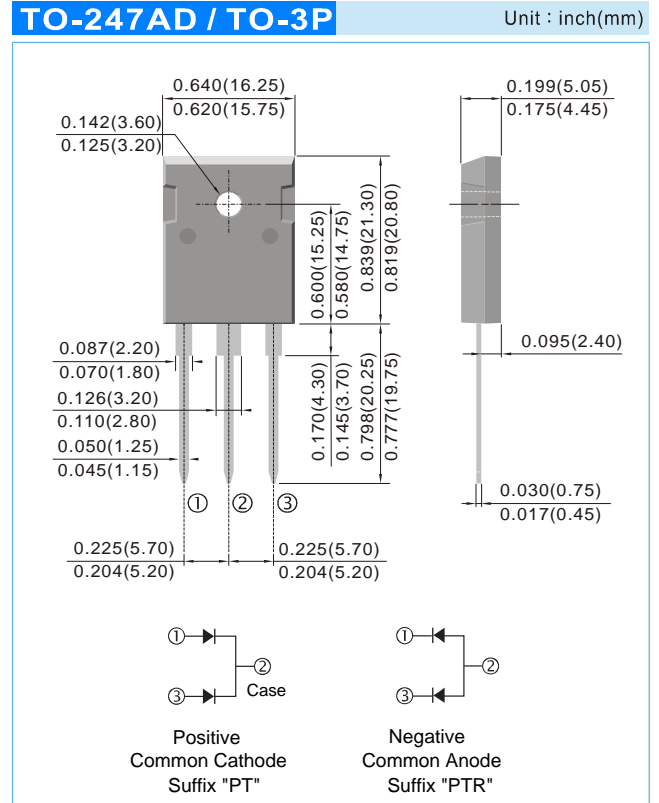

MAXIMUM RATINGS AND ELECTRICAL CHARACTERISTICS

Rating at 25°C ambient temperature unless otherwise specified.
Single phase, half wave, 60Hz, resistive or inductive load.
For capacitive load, derate current by 20%.

| | SYMBOL | MUR 6020PT/R | MUR 6040PT/R | MUR 6060PT/R | MUR 6080PT/R | MUR 60100PT/R | UNIT |
|---|----------|--------------|--------------|--------------|--------------|---------------|----------|
| Maximum Recurrent Peak Reverse Voltage | VRRM | 200 | 400 | 600 | 800 | 1000 | V |
| Maximum RMS Voltage | VRMS | 140 | 280 | 420 | 560 | 700 | V |
| Maximum DC Blocking Voltage | VDC | 200 | 400 | 600 | 800 | 1000 | V |
| Maximum Average Forward Rectified Current Tc=125°C (Total Device 2x30A=60A) | IF(AV) | 60.0 | | | | | A |
| Peak Forward Surge Current, 8.3ms single Half sine-wave superimposed on rated load (JEDEC method) | IFSM | 600 | | | | | A |
| Maximum Instantaneous Forward Voltage @ 30.0 A (Per Diode/Per Leg) | VF | 0.98 | 1.3 | 1.5 | 1.7 | 1.9 | V |
| Maximum DC Reverse Current @Tj=25°C At Rated DC Blocking Voltage @Tj=125°C | IR | 10 500 | | | | | uA uA |
| Maximum Reverse Recovery Time (Note 1) | Trr | 35 | | | 50 | | nS |
| Typical junction Capacitance (Note 2) | CJ | 150 | | | | | pF |
| Operating Junction and Storage Temperature Range | TJ, TSTG | -55 to +150 | | | | | °C |

NOTES : (1) Reverse recovery test conditions $I_F = 0.5A$ $I_R = 1.0A$ $I_{rr} = 0.25A$.
(2) Thermal Resistance junction to terminal.
(3) Measured at 1.0 MHz and applied reverse voltage of 4.0 Volts DC.

CURRENT 60 Ampere
 VOLTAGE RANG 200 to 1000 Volts

MUR6020PT THRU MUR60100PTR

RATING AND CHARACTERISTIC CURVES

FIG.1 - FORWARD CURRENT DERATING CURVE

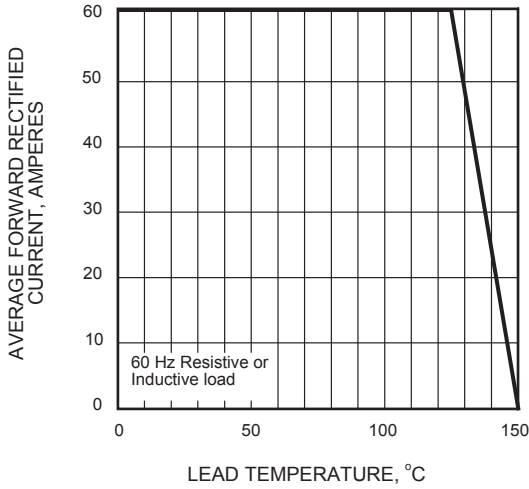

FIG.2 - MAXIMUM NON-REPETITIVE PEAK FORWARD SURGE CURRENT

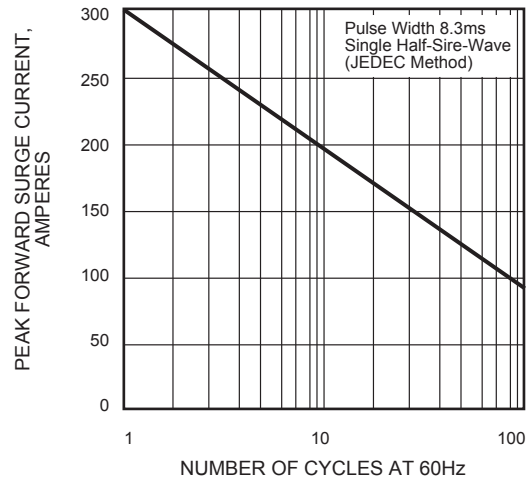

FIG.3 - TYPICAL INSTANTANEOUS FORWARD CHARACTERISTICS

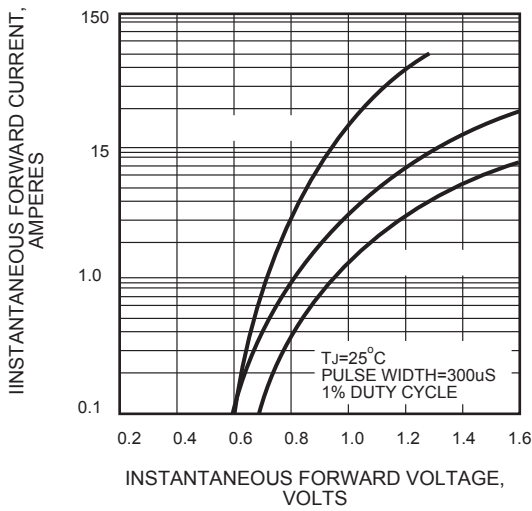

FIG.4 - TYPICAL REVERSE CHARACTERISTICS

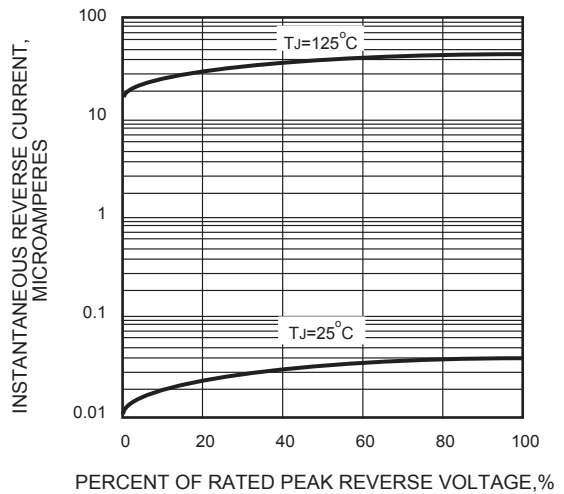
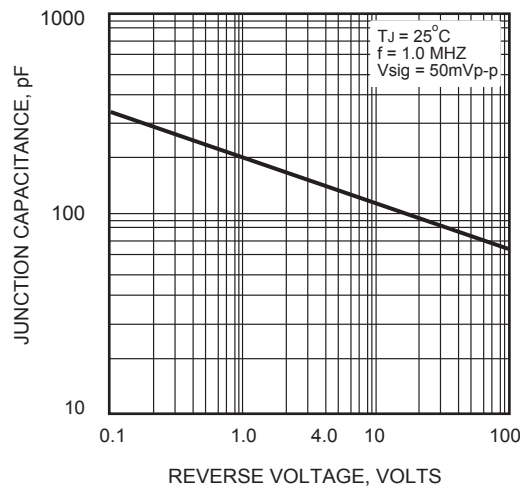

FIG.5 - TYPICAL JUNCTION CAPACITANCE



CURRENT 60 Ampere
 VOLTAGE RANG 200 to 1000 Volts

MUR6020PT THRU MUR60100PTR

T0-247AD

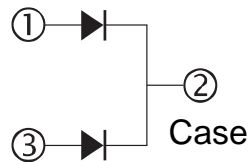
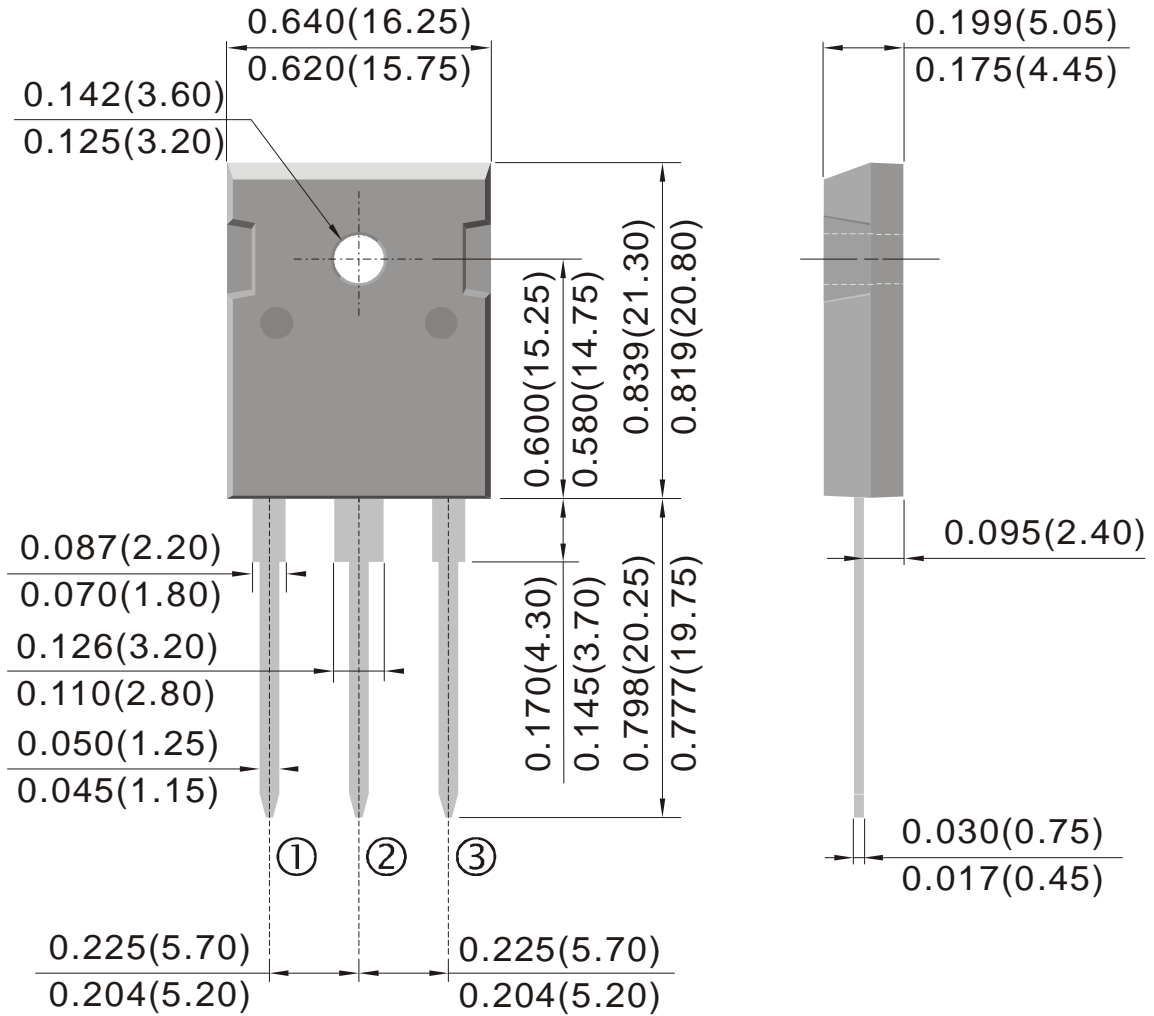

Positive
 Common Cathode
 Suffix "PT"

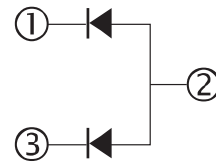

Negative
 Common Anode
 Suffix "PTR"

CURRENT 60 Ampere
 VOLTAGE RANG 200 to 1000 Volts

MUR6020PT THRU MUR60100PTR

T0-247S

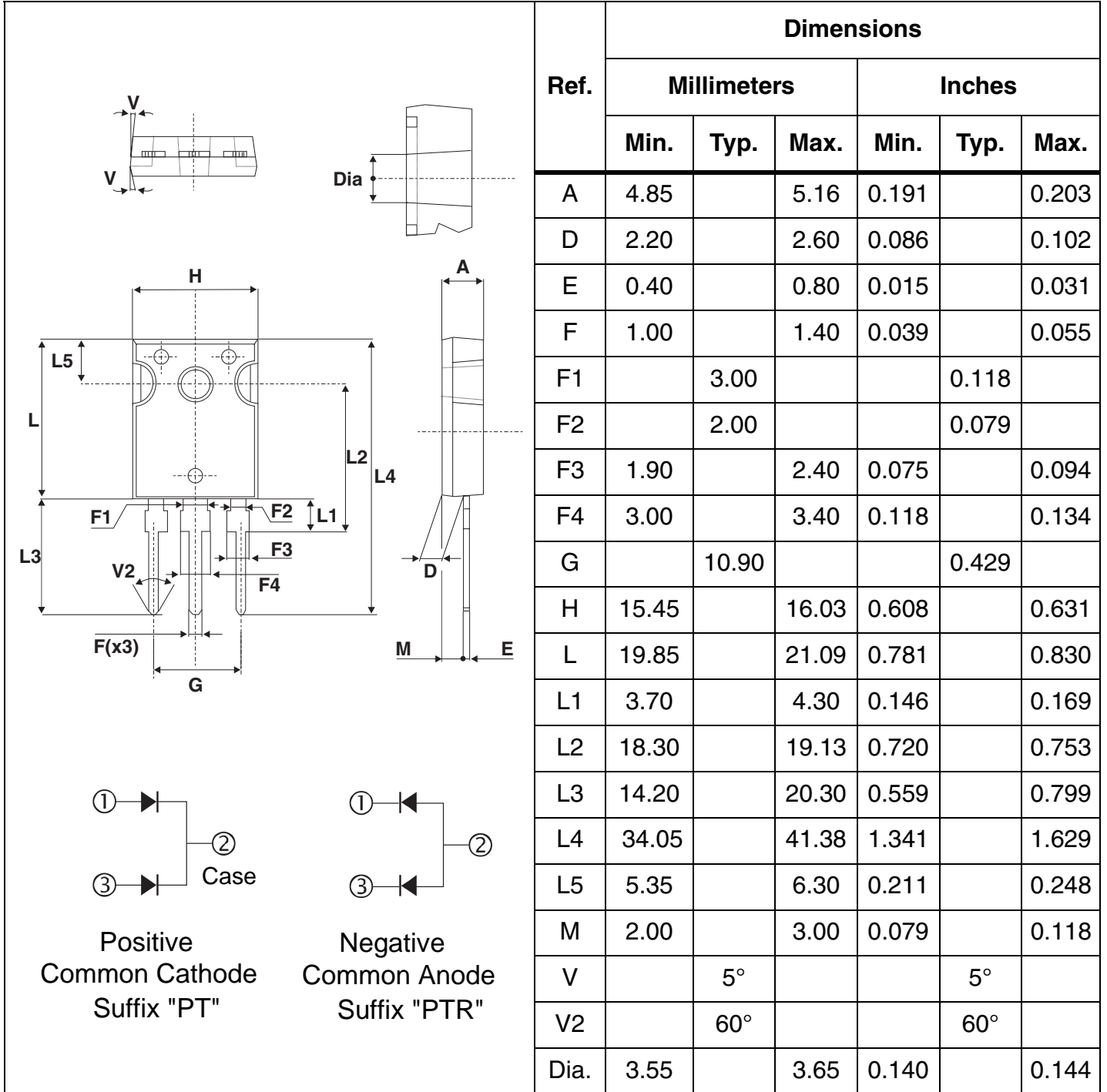

CURRENT 60 Ampere

VOLTAGE RANG 200 to 1000 Volts

MUR6020PT THRU MUR60100PTR

TO-3P

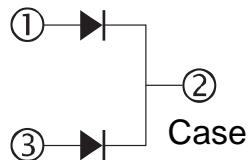
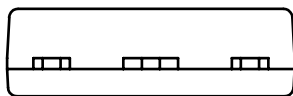
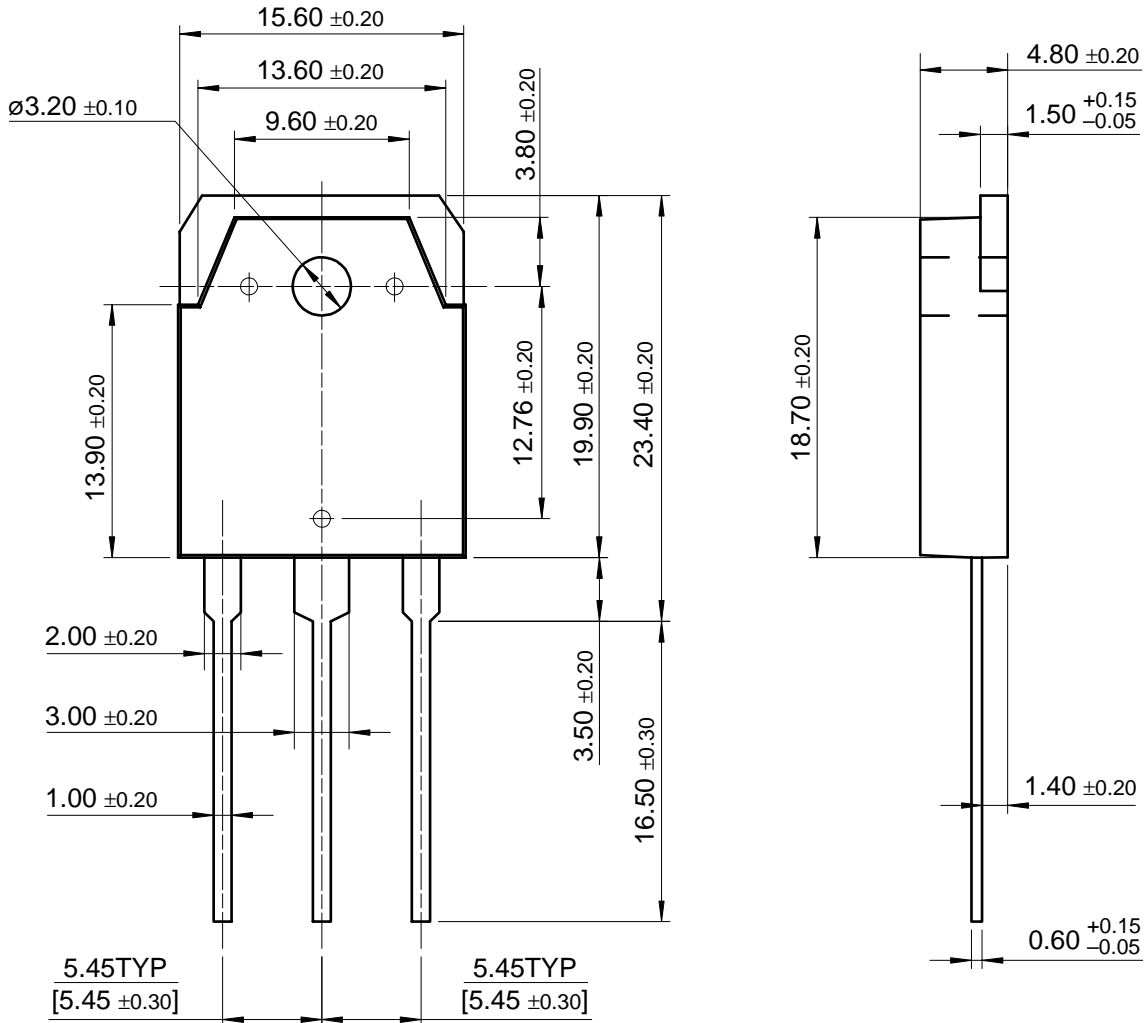

Positive
Common Cathode
Suffix "PT"

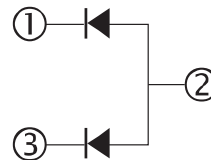

Negative
Common Anode
Suffix "PTR"